

LEADING IN
PRODUCTION
EFFICIENCY

www.durr.com



Dürr Gluing Solutions

State-of-the-Art Adhesive Techniques Improve Quality and Efficiency in Production

Gluing technology for bodywork, final assembly and battery production

One of the main requirements of modern vehicles is to reduce or prevent CO₂ emissions. A key to this is the development of innovative lightweight construction concepts that involve combining different materials. Adhesive techniques play a crucial role in joining materials, both in bodywork and final assembly.

The transition to electromobility with the production of battery modules, battery packs and control units also requires casting, filling, sealing and gluing materials for thermal management, sealing and joining. Dürr's modular system offers products and solutions for these different applications.

Gluing process in bodywork

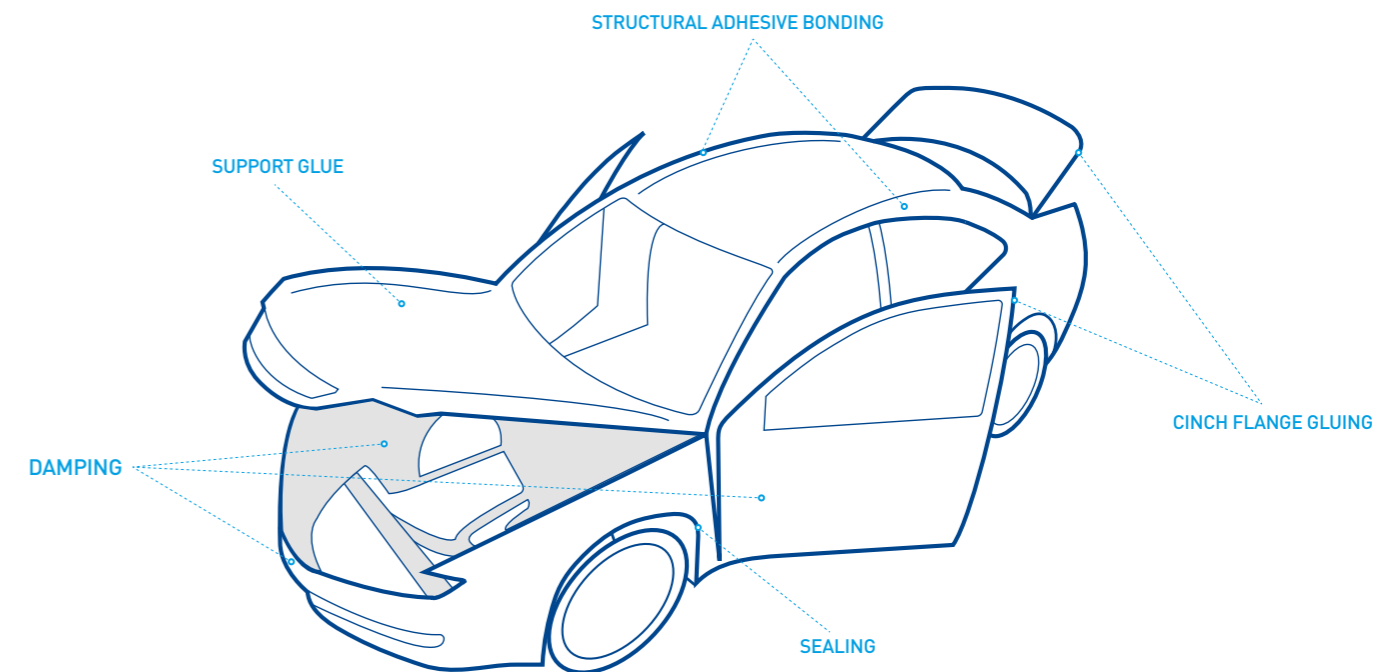

Adhesive connections are subject to considerable demands in bodywork. They must transmit loads reliably and be resistant to the loads that occur throughout the entire service life of the car body.

In bodywork, gluing as a joining procedure is highly suited for connecting different parts and components, especially in cases involving dynamic load.

Adhesive techniques enable not only lower unit costs compared to spot welding, but also offer advantages for sealing and damping. In addition, increasing demands on car safety, stiffness and comfort are better met. Even crevice corrosion and corrosion when different materials come into contact are prevented.

Gluing process in battery assembly

Safe energy for the mobility of tomorrow

PRECISE APPLICATION OF GLUES, SEALANTS AND FILLERS IN BATTERY PRODUCTION

Battery gluing is subject to the most stringent requirements, as the sensitive battery cells must be secure in the event of a collision. Essential for this is a precise application process that ensures an even distribution of the adhesives and sealing compounds and thus protects the cells against vibrations. A complete seal without air inclusions guarantees optimal thermal conductivity and prevents humidity from entering and gases produced from escaping.

The seal increases not only safety but also the life span of the entire battery.

Production quality extends the life span of batteries

COMPLETE PROVIDER FOR BATTERY GLUING

Dürr offers a complete solution in the application technology for battery gluing. A modular system for glue, sealant and filler application in battery production delivers high quality, flexibility, and adaptability for various viscosities and mixing ratios. In addition, Dürr develops innovative processes for the application of thermally conductive materials for thermal management. Dürr technology is configurable from processing small quantities in the laboratory and prototype construction to pre-series and series production.

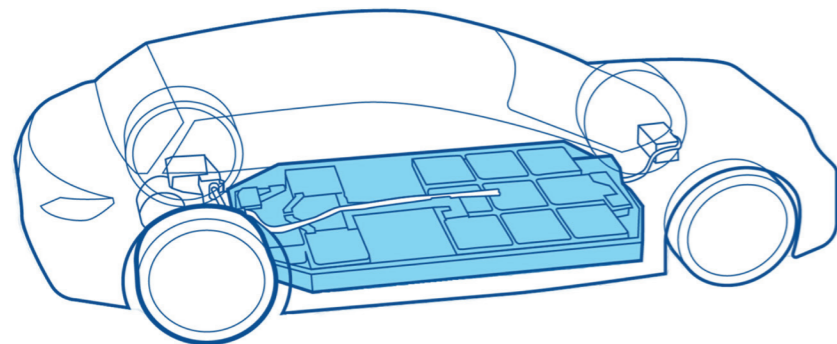

100%
FLEXIBILITY THANKS TO THE MODULAR
DÜRR SYSTEM FOR BATTERY GLUING

Gluing solutions for final assembly

Process efficiency for every job

GLUED CONNECTIONS

The automotive industry places numerous demands and requirements on adhesive connections, whose quantities, material costs, applications and quality vary greatly. Dürr develops turnkey solutions that provide the best answer to each of these tasks, offering a modularly designed adhesive system available for every application in final assembly.

Dürr carries out process simulations to perfectly conceptualize automated and semi-automated solutions and as robot-controlled and stationary application systems early on. Our Best Concept Determination method optimizes process and cycle times and reduces commissioning times.

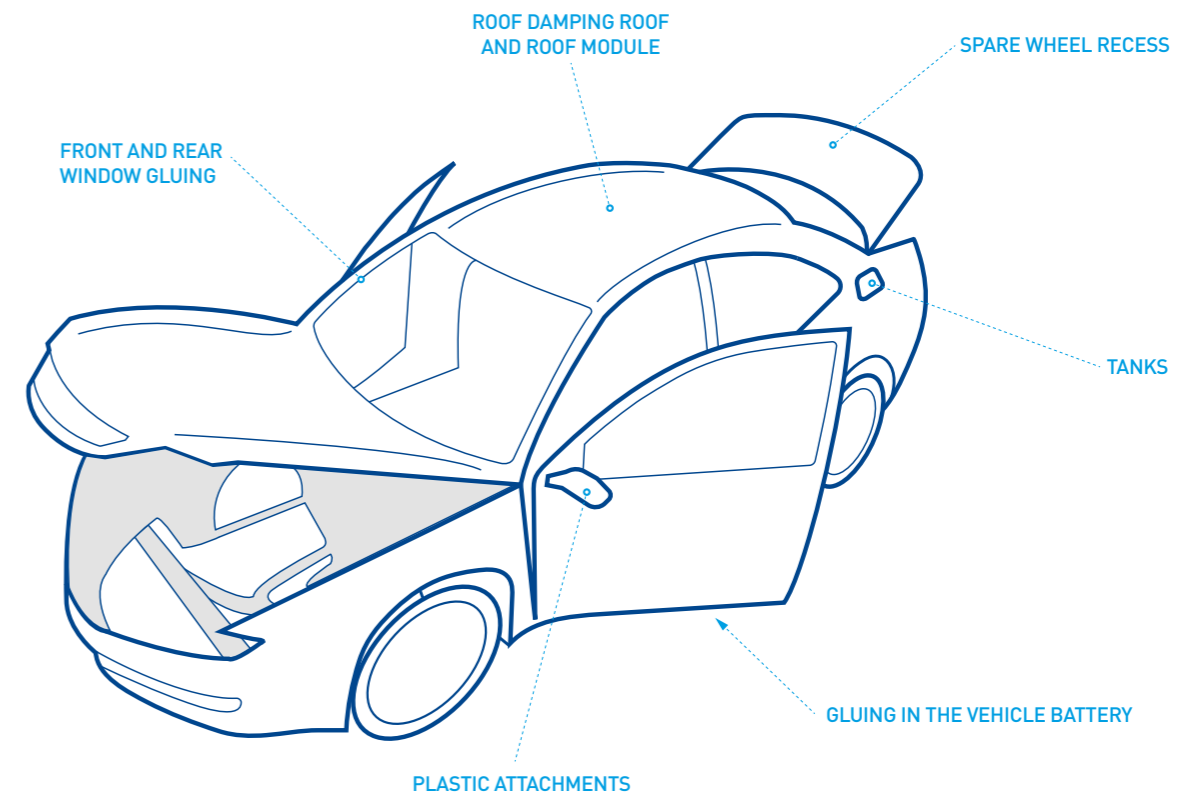

SINGLE SOURCING

Automated gluing in the final assembly of vehicle production uses high-viscosity materials that bond parts and components of different compositions evenly and permanently. Dürr offers comprehensive process expertise and a complete portfolio of products: The portfolio for pretreatment as well as gluing and assembly ranges from simple manual gluing stations to complex, fully automated robot cells.

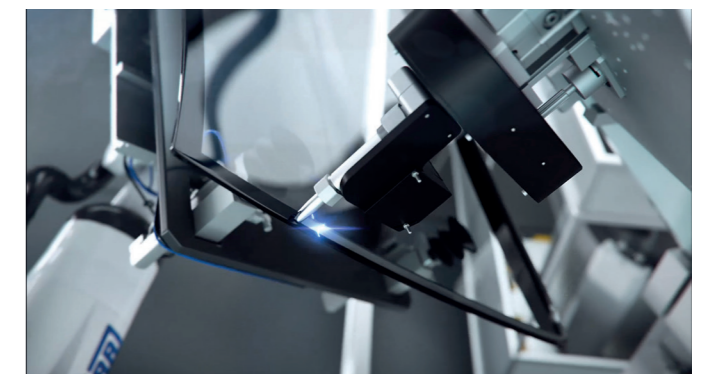

Fully automated gluing application

Everything from a single source: from the material supply system and robot-controlled application to software solutions

MATERIAL SUPPLY (20- 200 LITERS)

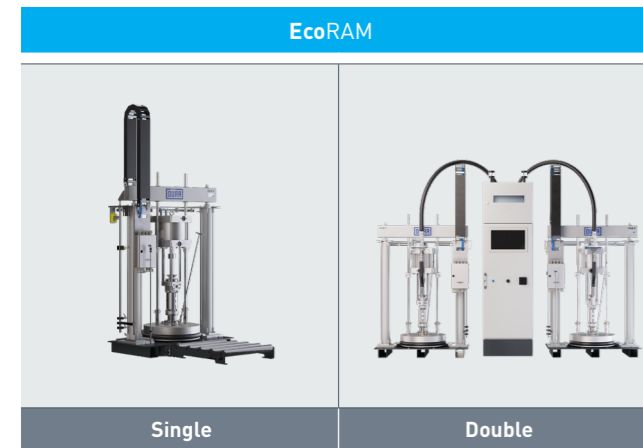

PUMPS



APPLICATORS

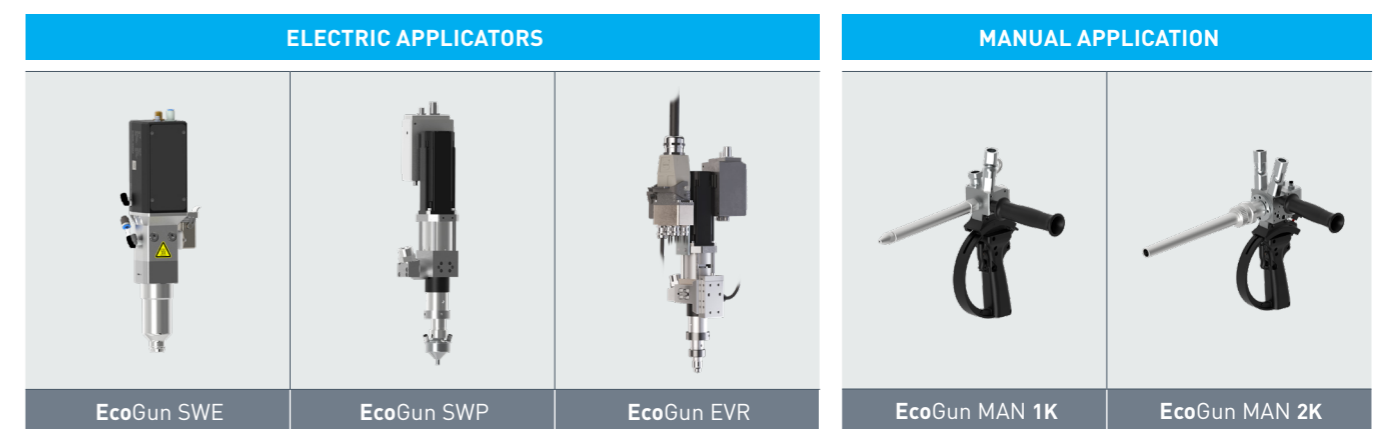

PUMP AND DOSING CONTROL

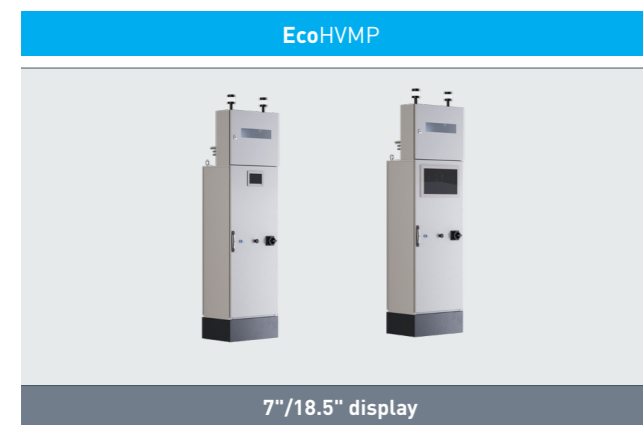

PRODUCTS FOR AUTOMATED ADHESIVE APPLICATION

Dürr has the necessary process and material expertise, and its modular product system is the optimal solution for every application.



DOSING UNITS

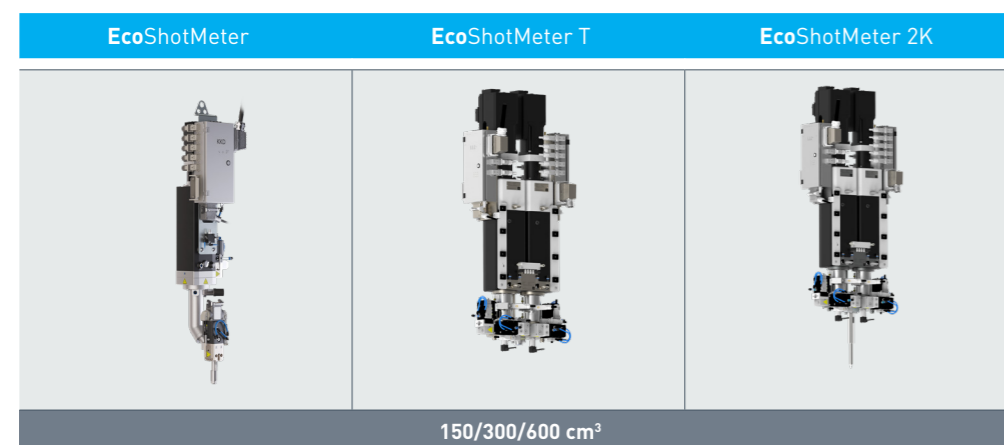

PRETREATMENT

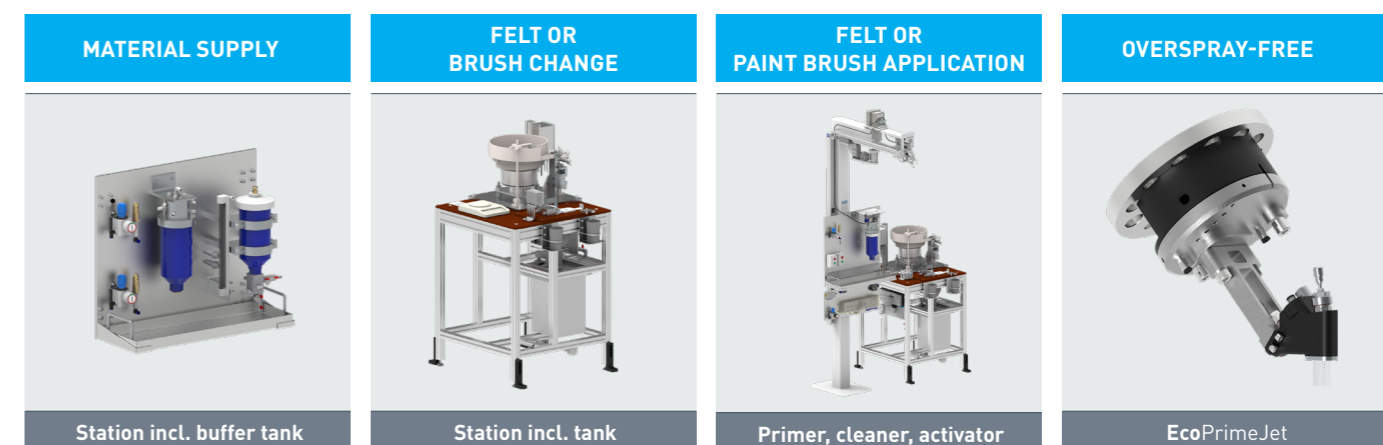

Modular systems. Individual solutions.

SIDE WINDOW BONDING IN CONTINUOUS PRODUCTION

Large-scale production of e-vehicles calls for even greater flexibility and an increase in the degree of automation in production. Volkswagen's Zwickau plant is using a new solution for the first time in side window bonding. Windows are fitted in line tracking mode, in other words, in continuous production. The body on the skilnet platform continuously moves while robots guide the side windows past the application tower for adhesive application and then put the

side windows in place. In the past, the side windows could be fitted using an automated process only when the conveyor was in stop-and-go mode.

First, a measurement system determines the exact position of the body, so that the side window can be inserted with an accuracy of a few tenths of a millimeter. Compared to stop-and-go application, at least two cycles are saved per passing car body.

PROCESS OPTIMIZATION

Increasing process stability reduces rework times. This means that an error-prone and time-consuming manual process is automated and stabilized. We have made further improvements in logistics. Supplying the windows in the required sequence is often time-consuming manual work, and sometimes takes place in a separate logistics area. In this project, a logistics module enables non-mixed transport containers for the side windows to be positioned directly on the line. A logistics robot removes the side window and makes it available to the installation robot.

One advantage of the new process is that the conveyor system no longer has to be adapted to stop-and-go production offering the car manufacturer considerable cost savings. The side window bonding unit can also be integrated at any point on the assembly line, resulting in maximum flexibility in production line design.

Dürr is the only manufacturer today to have implemented this flexible assembly method in series production for this application.

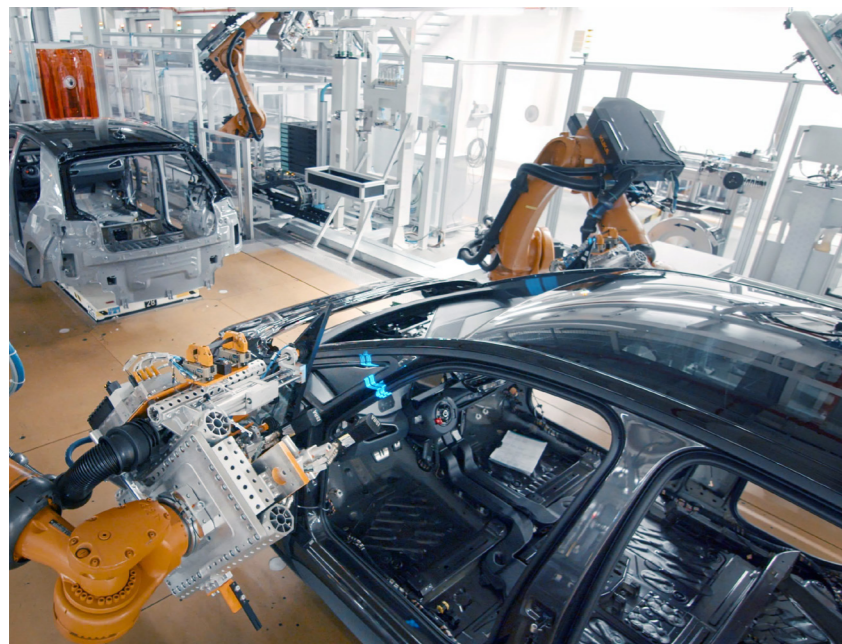

With the latest process for fully automatic gluing of the windows using the "line tracking mode," windows are installed in the vehicle automatically while the production line is running.



CONTINUOUS APPLICATION WITH THE FIRST TANDEM DOSING UNIT FOR 2K MATERIALS

Demand for electric vehicles is rising rapidly along with the need for lithium-ion batteries. In light of large quantities and short cycles, production is a challenge that can only be mastered with new process solutions.

GAP FILLER FOR THERMAL MANAGEMENT

Accelerating or charging an electric car always produces heat in the battery, which must escape to the outside to prevent overheating. Thermally conductive pastes facilitate this process. Two to three liters of these gap fillers are introduced per part into the gaps between the modules and the cooling system. The gap fillers make a decisive contribution to ensuring that the thermal management of an electric car battery functions optimally. The demands on the mixing quality of the pastes and exact dosing during casting are high, for weight reduction reasons.

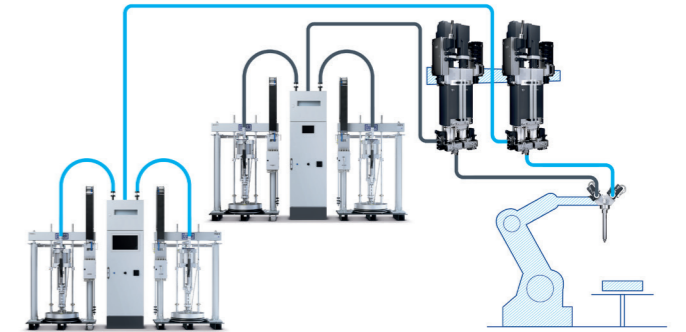

These requirements are met by volume-flow-controlled, high-precision piston dosing systems, which introduce the material into the intended cavities without bubbles and with maximum accuracy thanks to a high resolution. A tandem system with two dosing units working in opposite directions enables the first dosing unit to make the application while the second dosing unit fills its material chamber and is immediately ready for use when its counterpart is empty.

In this way, continuous application is possible without interrupting production to refill a chamber. Dürr can also continuously apply 2K thermal conductive to pastes with the high-precision tandem dosing unit, cutting time by a third compared to a conventional single system.

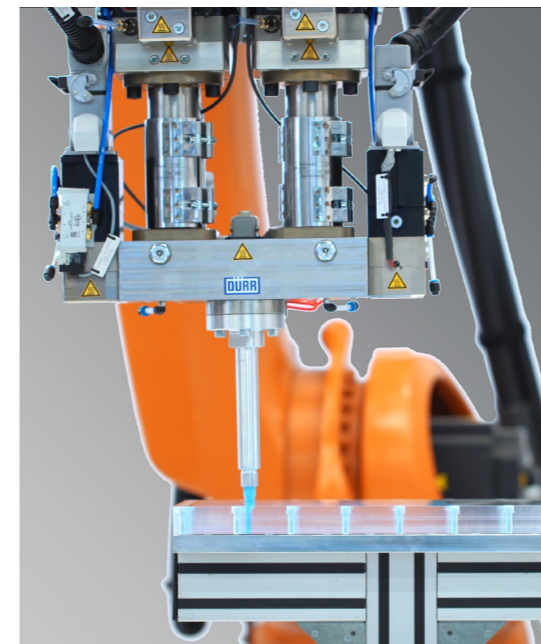

Gap filler for thermal management

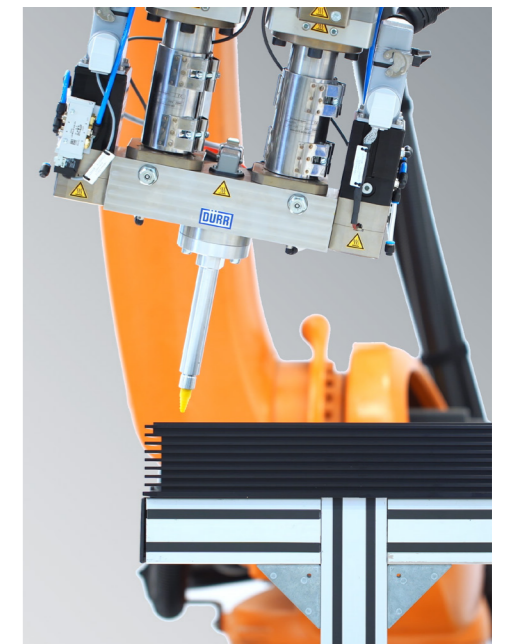
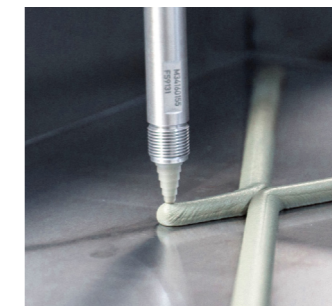

Dürr – your partner for gluing solutions

MODULAR SOLUTIONS

Dürr supports you in the layout design of your plants and responds flexibly to specific requirements and local conditions. The modular design of Dürr's solutions makes it possible to implement customer requirements with the highest precision and incorporate innovations down to the last detail.

MAXIMUM QUALITY

Robot-controlled application automates adhesive application and ensures optimum, reproducible process management and thus consistent adhesive bead quality. Automated fitting and application processes reduce cycle time and unit costs while also reducing error rates and the cost of spot repairs.

A FOCUS ON SUSTAINABILITY

The advance of lightweight and multi-material designs is placing new demands on the safety and comfort of automobiles. Dürr's innovative gluing solutions rely on efficient application processes with the lowest material consumption, this allowing us to tap into potential savings and promote sustainable production.

WORKLOAD REDUCTION

Automated solutions reduce the physical strain of component handling and prevent direct contact with potentially hazardous materials.



YOUR ADDED VALUE:

Everything from a single source: expertise in application, automation and robotics

Complete concept planning for the customer process

Shorter startup durations thanks to process simulation and robot programming

Very short cycle times and less adhesive agent use thanks to maximum precision

Gluing test centers

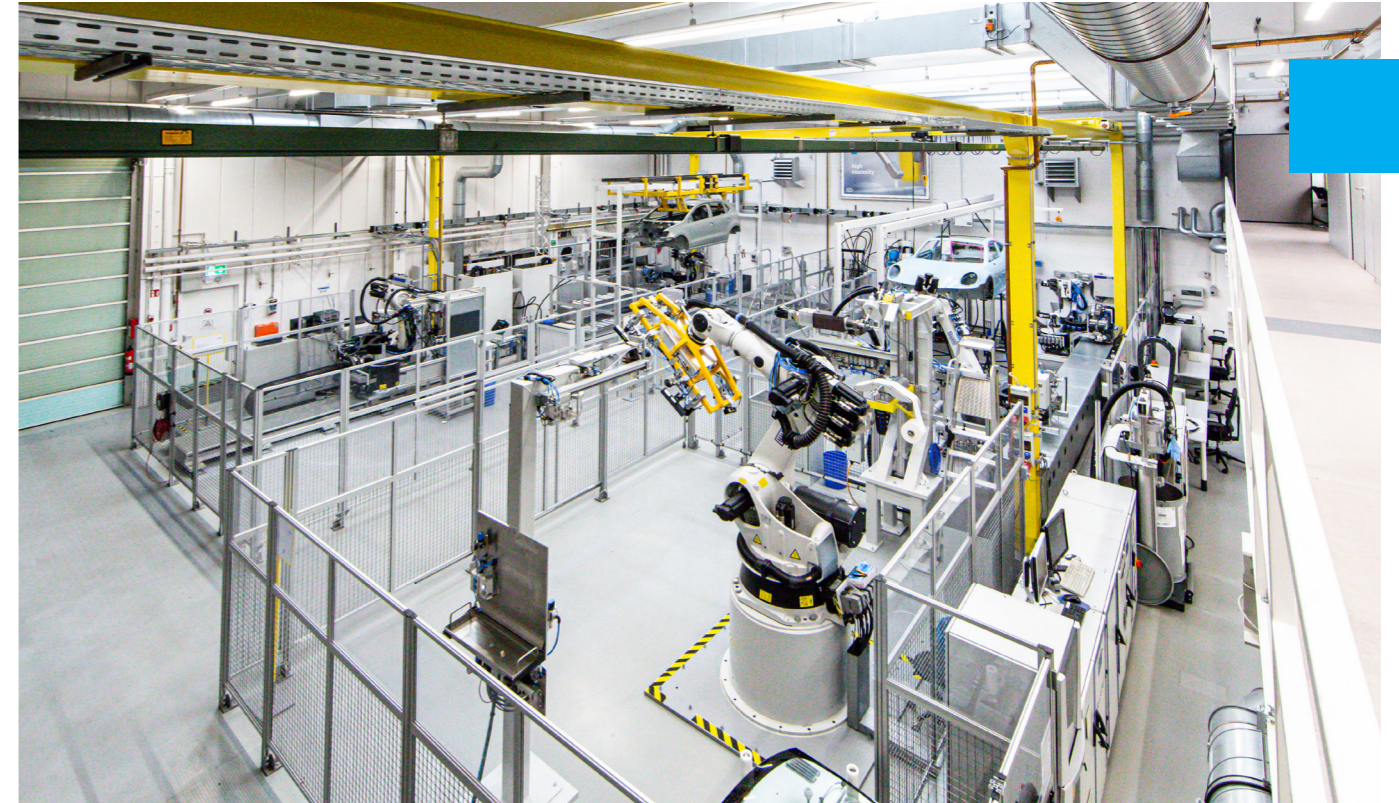

As an international partner of the automotive industry, Dürr has test centers in Bietigheim-Bissingen (Germany), Southfield (USA), Shanghai (China), Ulsan (South Korea) and São Paulo (Brazil). In the spirit of production efficiency, we offer a unique service in the form of test procedures that ensure the smooth and optimized start of production in your plant.

Our test centers have robots with and without movement axes, simple and high-end dosing systems and applicators for all process types.

Our test centers allow you to perform gluing applications in trials, develop products and processes for your specific needs, and validate new products.



TEST CENTER SERVICES

Processes and components are tested nearing series production and under real conditions

Development of customer-specific solutions

Processes are optimized without affecting ongoing production

Risks before production start are greatly reduced

Process development

Basic research tests with adhesives, thermal conductive pastes or other highly viscous media as well as process testing and optimization



LEADING IN PRODUCTION EFFICIENCY



Dürr Systems AG
Carl-Benz-Str. 34
74321 Bietigheim-Bissingen
Germany

Phone +49 (0) 7142 78-0
Email info@durr.com
www.durr.com



Subject to change. The information in this brochure contains only general descriptions or performance characteristics which may vary in actual cases. The requested performance parameters shall be binding only if they are explicitly agreed within the sales contract. © 2022 Dürr-Systems AG